

FLOOR DRAINS

ECO 10x10

Code	Outlet	Size	
HORIZONTAL OUTLET			
3011.0Y050K.010.1	Ø 50	10x10 cm	100

*Plastic body / Stainless grid / Odor blocking by water
 *пластичное тело / Нержавеющая решетка / Гидрозатвор
 هيكل بلاستيكي / شبكة مقاومة للصدأ / حابس رائحة مائي بصمام

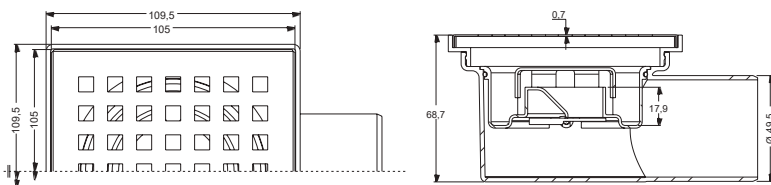

LINE 10x10

Code	Outlet	Size	
HORIZONTAL OUTLET			
3012.0Y032K.010.1	Ø 32	10x10 cm	160
3012.0Y040K.010.1	Ø 40	10x10 cm	100
3012.0Y050K.010.1	Ø 50	10x10 cm	100
3012.0Y070K.010.1	Ø 70	10x10 cm	80
VERTICAL OUTLET			
3012.0A040K.010.1	Ø 40	10x10 cm	140
3012.0A050K.010.1	Ø 50	10x10 cm	140
3012.0A070K.010.1	Ø 70	10x10 cm	140

ELITE LINE BLISTER

3012.0Y032K.010.B	Ø 32	10x10 cm	40
3012.0Y050K.010.B	Ø 50	10x10 cm	40

*Plastic body / Stainless grid / Odor blocking by water
 *пластичное тело / Нержавеющая решетка / Гидрозатвор
 هيكل بلاستيكي / شبكة مقاومة للصدأ / حابس رائحة مائي بصمام

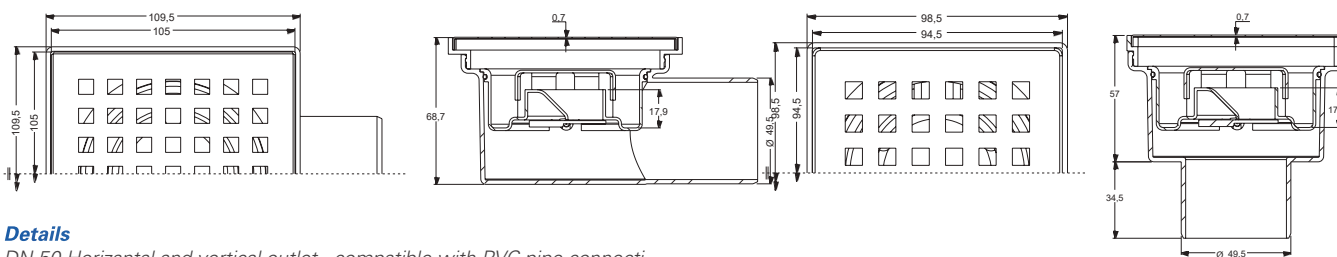

Details

DN 50 Horizontal and vertical outlet - compatible with PVC pipe connections, blocking odor by water (36mm). The flow rate is 32 liters/min. Resistant against external chemical effects, operating temperature is between -30°C and +75°C. The grid is made of 304 grade stainless steel.

Advantages

With its 304 grade stainless steel grid, it has a quality and stylish-looking. It can be easily applied at floor. With its odor blocking by water support, it prevents the bad smell coming from the installation. With its adjustable height legs, it can be adjusted depending on the screed concrete. High resistance against the organic and inorganic chemicals, resistant against most acidic and salty aqueous oxidation.

Areas of Usage

Common use of bathroom shower, hospital and hotel shower areas, locker-room shower areas etc.

Customized Production

Grid patterns can be chosen in gold, bronze or other optional colors in accordance with your desire.

Warning

It is not recommended to use high-density cleaners for a long-time.



LINE 15x15



Code	Outlet	Size	
HORIZONTAL OUTLET			
3012.0Y032K.015.1	Ø 32	15x15 cm	80
3012.0Y040K.015.1	Ø 40	15x15 cm	60
3012.0Y050K.015.1	Ø 50	15x15 cm	60
3012.0Y070K.015.1	Ø 70	15x15 cm	50
VERTICAL OUTLET			
3012.0A040K.015.1	Ø 40	15x15 cm	60
3012.0A050K.015.1	Ø 50	15x15 cm	60
3012.0A070K.015.1	Ø 70	15x15 cm	60

*Plastic body / Stainless grid / Odor blocking by water
 *пластичное тело / Нержавеющая решетка / Гидрозатвор
 هيكل بلاستيكي / شبكة مقاومة للصدأ / حابس رائحة مائي بصمام

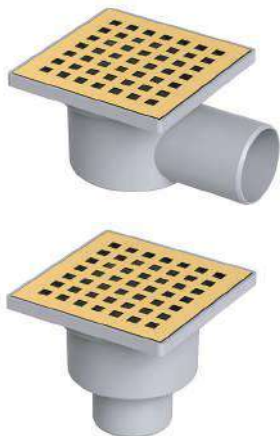
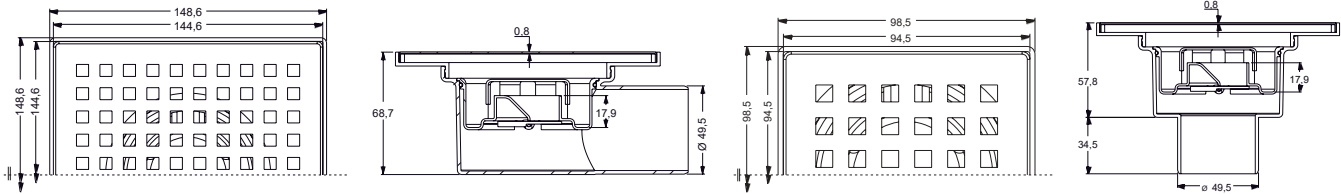

LINE GOLD 10x10

Code	Outlet	Size	
HORIZONTAL OUTLET			
3012.0Y032G.010.1	Ø 32	10x10 cm	160
3012.0Y040G.010.1	Ø 40	10x10 cm	100
3012.0Y050G.010.1	Ø 50	10x10 cm	100
3012.0Y070G.010.1	Ø 70	10x10 cm	80
VERTICAL OUTLET			
3012.0A040G.010.1	Ø 40	10x10 cm	140
3012.0A050G.010.1	Ø 50	10x10 cm	140
3012.0A070G.010.1	Ø 70	10x10 cm	140

*Plastic body / Stainless grid / Odor blocking by water
 *пластиковый ствол / нержавеющая решетка
 هيكل بلاستيكي / شبكة مقاومة للصدأ / حابس رائحة مائي بصمام

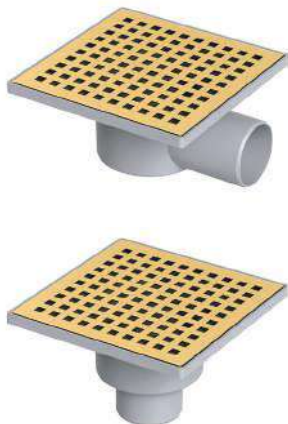

LINE GOLD 15x15

Code	Outlet	Size	
HORIZONTAL OUTLET			
3012.0Y032G.015.1	Ø 32	15x15 cm	80
3012.0Y040G.015.1	Ø 40	15x15 cm	60
3012.0Y050G.015.1	Ø 50	15x15 cm	60
3012.0Y070G.015.1	Ø 70	15x15 cm	50
VERTICAL OUTLET			
3012.0A040G.015.1	Ø 40	15x15 cm	60
3012.0A050G.015.1	Ø 50	15x15 cm	60
3012.0A070G.015.1	Ø 70	15x15 cm	60

*Plastic body / Stainless grid / Odor blocking by water
 *пластичное тело / Нержавеющая решетка / Гидрозатвор
 هيكل بلاستيكي / شبكة مقاومة للصدأ / حابس رائحة مائي بصمام

FLOOR DRAINS

LEGAL 10x10

Code	Outlet	Size	
HORIZONTAL OUTLET			
3013.0Y032K.010.1	Ø 32	10x10 cm	160
3013.0Y040K.010.1	Ø 40	10x10 cm	100
3013.0Y050K.010.1	Ø 50	10x10 cm	100
3013.0Y070K.010.1	Ø 70	10x10 cm	80
VERTICAL OUTLET			
3013.0A040K.010.1	Ø 40	10x10 cm	140
3013.0A050K.010.1	Ø 50	10x10 cm	140
3013.0A070K.010.1	Ø 70	10x10 cm	140
ELITE LEGAL BLISTER			
3013.0Y032K.010.B	Ø 32	10x10 cm	40
3013.0Y050K.010.B	Ø 50	10x10 cm	40

*Plastic body / Stainless grid / Stainless frame / Odor blocking with vet and dry system
 *пластичное тело / Нержавеющая решетка и рама / Гидрозатвор
 هيكل بلاستيكي / شبكة وإطار مقاوم للصدأ / حابس رائحة مائي بصمام

LEGAL 15x15

Code	Outlet	Size	
HORIZONTAL OUTLET			
3013.0Y032K.015.1	Ø 32	15x15 cm	80
3013.0Y040K.015.1	Ø 40	15x15 cm	60
3013.0Y050K.015.1	Ø 50	15x15 cm	60
3013.0Y070K.015.1	Ø 70	15x15 cm	50
VERTICAL OUTLET			
3013.0A040K.015.1	Ø 40	15x15 cm	60
3013.0A050K.015.1	Ø 50	15x15 cm	60
3013.0A070K.015.1	Ø 70	15x15 cm	60

*Plastic body / Stainless grid / Stainless frame / Odor blocking with vet and dry system
 *пластичное тело / Нержавеющая решетка и рама / Гидрозатвор
 هيكل بلاستيكي / شبكة وإطار مقاوم للصدأ / حابس رائحة مائي بصمام



Details

DN 50 Horizontal and vertical outlet - compatible with PVC pipe connections, blocking odor by water (36mm). The flow rate is 32 liters/min. Resistant against external chemical effects, operating temperature is between -30°C and +75°C. The grid is made of 304 grade stainless steel.

Advantages

With its 304 grade stainless steel grid, it has a quality and stylish-looking. It can be easily applied at floor. With its odor blocking by water support, it prevents the bad smell coming from the installation. With its adjustable height legs, it can be adjusted depending on the screed concrete. High resistance against the organic and inorganic chemicals, resistant against most acidic and salty aqueous oxidation.

Areas of Usage

Common use of bathroom shower, hospital and hotel shower areas, locker-room shower areas etc.

Customized Production

Grid patterns can be chosen in gold, bronze or other optional colors in accordance with your desire.

Warning

It is not recommended to use high-density cleaners for a long-time.

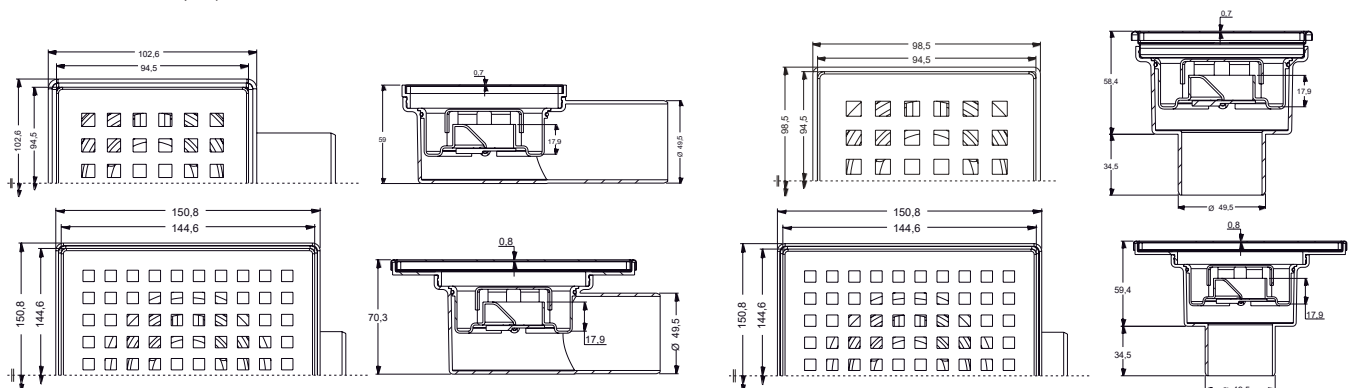

SQUARE



INDEX

KUCA



Code	Outlet	Size	
VERTICAL OUTLET			
5710.0A050K.010.1	Ø 50	10x10 cm	140
5710.0A070K.010.1	Ø 70	10x10 cm	140

*Plastic body / Stainless grid
 *пластичное тело / Нержавеющая решетка
 هيكل بلاستيكي / شبكة مقاومة للصدأ

SCALA 10x10



Code	Outlet	Size	
HORIZONTAL OUTLET			
3014.0Y032K.010.9	Ø 32	10x10 cm	100
3014.0Y050K.010.9	Ø 50	10x10 cm	100
VERTICAL OUTLET			
3014.0A050K.010.9	Ø 50	10x10 cm	120

*Plastic body / Stainless steel grid and frame / Odor blocking by water
 *пластичное тело / Нержавеющая решетка и рама / Гидрозатвор
 هيكل بلاستيكي / شبكة وإطار مقاوم للصدأ / حابس رائحة مائي بصمام

SCALA 15x15



Code	Outlet	Size	
HORIZONTAL OUTLET			
3014.0Y032K.015.9	Ø 32	15x15 cm	60
3014.0Y050K.015.9	Ø 50	15x15 cm	60
VERTICAL OUTLET			
3014.0A050K.015.9	Ø 50	15x15 cm	60

*Plastic body / Stainless steel grid and frame / Odor blocking by water
 *пластичное тело / Нержавеющая решетка и рама / Гидрозатвор
 هيكل بلاستيكي / شبكة وإطار مقاوم للصدأ / حابس رائحة مائي بصمام

BALCONY DRAINER



Code	Outlet	
Ø70		
6001.0A070.13.0	Ø 70	100
Ø100		
6002.0A100.16.0	Ø 100	64

Plastic body
 пластиковое тело
 هيكل بلاستيكي

FLOOR DRAINS

MIDI 10X10

Code	Outlet	Size	
HORIZONTAL OUTLET			
5001.0Y032.010.1	Ø 32	10x10 cm	80
5001.0Y040.010.1	Ø 40	10x10 cm	60
5001.0Y050.010.1	Ø 50	10x10 cm	60
5001.0Y070.010.1	Ø 70	10x10 cm	50
VERTICAL OUTLET			
5001.0A040.010.1	Ø 40	10x10 cm	50
5001.0A050.010.1	Ø 50	10x10 cm	50
5001.0A070.010.1	Ø 70	10x10 cm	50



Plastic body, Ss Grid/ Odor trap
 пластиковое тело / Нержавеющая решетка / Мокрый Затвор
 هيكل بلاستيكي / شبكة مقاومة للصدأ / حابس رائحة كريهه بصمام

STD. 10x10

Code	Outlet	Size	
HORIZONTAL OUTLET			
5002.0Y032.010.1	Ø 32	10x10 cm	60
5002.0Y040.010.1	Ø 40	10x10 cm	50
5002.0Y050.010.1	Ø 50	10x10 cm	50
5002.0Y070.010.1	Ø 70	10x10 cm	30
5002.0Y100.010.1	Ø 100	10x10 cm	20
VERTICAL OUTLET			
5002.0A040.010.1	Ø 40	10x10 cm	50
5002.0A050.010.1	Ø 50	10x10 cm	50
5002.0A070.010.1	Ø 70	10x10 cm	50
5002.0A100.010.1	Ø 100	10x10 cm	30



Plastic body, Ss Grid/ Odor trap
 пластиковое тело / Нержавеющая решетка / Мокрый Затвор
 هيكل بلاستيكي / شبكة مقاومة للصدأ / حابس رائحة كريهه بصمام

STD. MESH 10X10

Code	Outlet	Size	
HORIZONTAL OUTLET			
5002.FY032.010.1	Ø 32	10x10 cm	30
5002.FY040.010.1	Ø 40	10x10 cm	20
5002.FY050.010.1	Ø 50	10x10 cm	20
5002.FY070.010.1	Ø 70	10x10 cm	20
5002.FY100.010.1	Ø 100	10x10 cm	10
VERTICAL OUTLET			
5002.FA040.010.1	Ø 40	10x10 cm	20
5002.FA050.010.1	Ø 50	10x10 cm	20
5002.FA070.010.1	Ø 70	10x10 cm	20
5002.FA100.010.1	Ø 100	10x10 cm	10



Plastic body, Ss Grid/ Odor trap/Mesh
 Нержавеющая решетка / мокрый затвор / с мембраном
 هيكل بلاستيكي / شبكة مقاومة للصدأ / حابس رائحة كريهه بصمام

STD. TEXTILE MEMBRANE 10X10

Code	Outlet	Size	
HORIZONTAL OUTLET			
5002.TY032.010.1	Ø 32	10x10 cm	30
5002.TY040.010.1	Ø 40	10x10 cm	20
5002.TY050.010.1	Ø 50	10x10 cm	20
5002.TY070.010.1	Ø 70	10x10 cm	20
5002.TY100.010.1	Ø 100	10x10 cm	10
VERTICAL OUTLET			
5002.TA040.010.1	Ø 40	10x10 cm	20
5002.TA050.010.1	Ø 50	10x10 cm	20
5002.TA070.010.1	Ø 70	10x10 cm	20
5002.TA100.010.1	Ø 100	10x10 cm	10

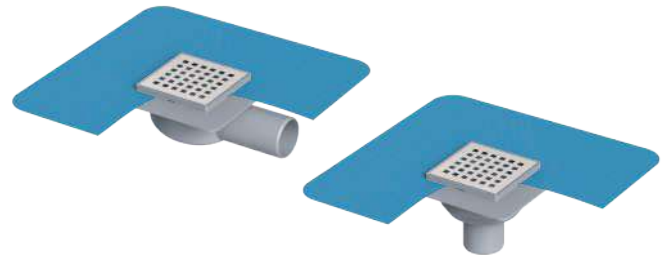

Plastic body, Ss Grid/ Odor trap/Membrane
 пластиковое тело / Нержавеющая решетка / Мокрый Затвор/Мембраны
 هيكل بلاستيكي / شبكة مقاومة للصدأ / حابس رائحة كريهه بصمام

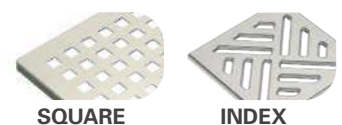



PREMIUM 10x10

Code	Outlet	Size	
HORIZONTAL OUTLET			
3045.0Y032K.010.1	Ø 32	10x10 cm	24
3045.0Y050K.010.1	Ø 50	10x10 cm	24
VERTICAL OUTLET			
3045.0A050K.010.1	Ø 50	10x10 cm	24

*Stainless body / Stainless steel grid / Stainless scent holder
 Корпус из нержавеющей стали / Нержавеющая решетка
 هيكل مقاوم للصدأ / شبكة مقاومة للصدأ / حابس رائحة غير القابل للصدأ

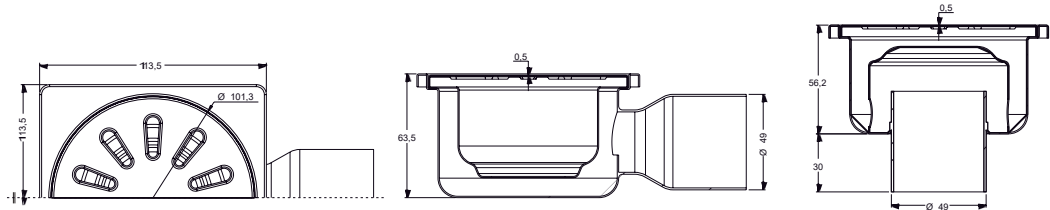

PREMIUM 15X15



Code	Outlet	Size	
HORIZONTAL OUTLET			
3045.0Y032K.015.1	Ø 32	15x15 cm	24
3045.0Y050K.015.1	Ø 50	15x15 cm	24
3045.0Y070K.015.1	Ø 70	15x15 cm	24
VERTICAL OUTLET			
3045.0A050K.015.1	Ø 50	15x15 cm	24
3045.0A070K.015.1	Ø 70	15x15 cm	24

*Stainless body / Stainless steel grid / Stainless scent holder
 Корпус из нержавеющей стали / Нержавеющая решетка
 هيكل مقاوم للصدأ / شبكة مقاومة للصدأ / حابس رائحة غير القابل للصدأ

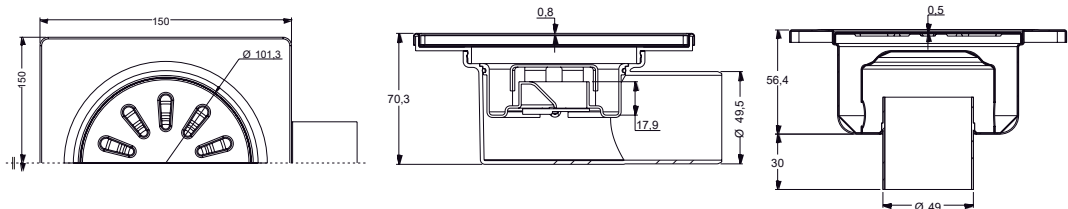

PREMIUM 20x20



Code	Outlet	Size	
HORIZONTAL OUTLET			
3045.0Y070K.020.1	Ø 70	20x20 cm	12
3045.0Y100K.020.1	Ø 100	20x20 cm	12
VERTICAL OUTLET			
3045.0A070K.020.1	Ø 70	20x20 cm	12
3045.0A100K.020.1	Ø 100	20x20 cm	12

*Stainless body / Stainless steel grid / Stainless scent holder
 Корпус из нержавеющей стали / Нержавеющая решетка
 هيكل مقاوم للصدأ / شبكة مقاومة للصدأ / حابس رائحة غير القابل للصدأ

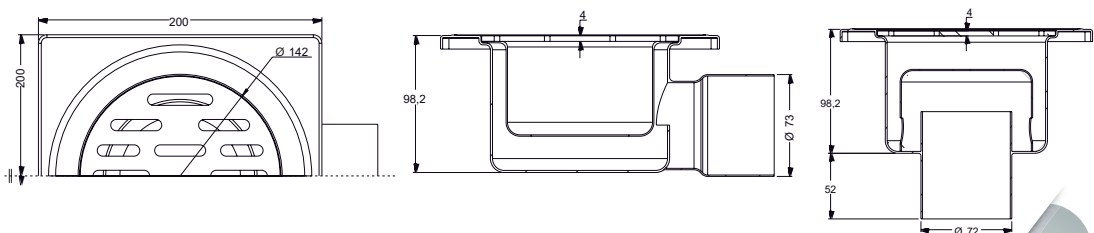

FLOOR DRAINS

MAXIFLOW

PREMIUM SLIM 10X10

Code	Outlet	Size	
HORIZONTAL OUTLET			
3046.0Y040K.010.1	Ø 40	10x10 cm	50
3046.0Y050K.010.1	Ø 50	10x10 cm	50
VERTICAL OUTLET			
3045.0A050K.015.1	Ø 50	10x10 cm	24
3045.0A070K.015.1	Ø 70	10x10 cm	24

*Stainless body / Stainless steel grid / Stainless scent holder
 Корпус из нержавеющей стали / Нержавеющая решетка
 هيكل مقاوم للصدأ / شبكة مقاومة للصدأ / حابس رائحة غير القابل للصدأ

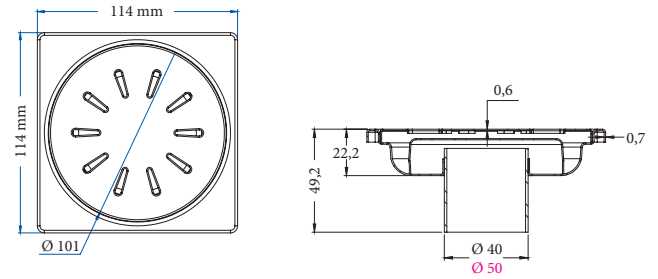
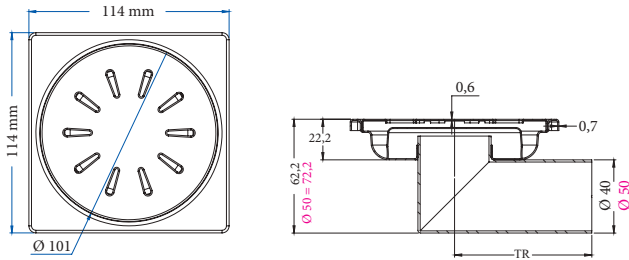

PREMIUM SLIM 15X15

Code	Outlet	Size	
HORIZONTAL OUTLET			
3046.0Y040K.015.1	Ø 40	15x15 cm	50
3046.0Y050K.015.1	Ø 50	15x15 cm	50
VERTICAL OUTLET			
3046.0A040K.015.1	Ø 50	15x15 cm	50
3046.0A050K.015.1	Ø 70	15x15 cm	50

*Stainless body / Stainless steel grid / Stainless scent holder
 Корпус из нержавеющей стали / Нержавеющая решетка
 هيكل مقاوم للصدأ / شبكة مقاومة للصدأ / حابس رائحة غير القابل للصدأ

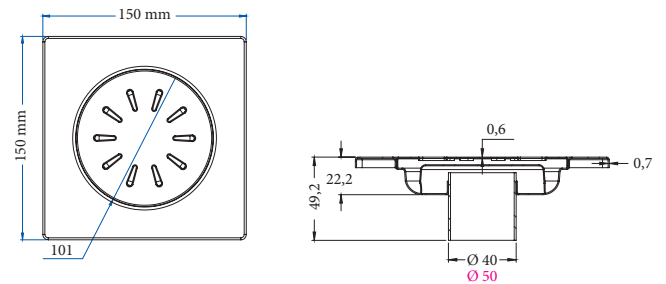
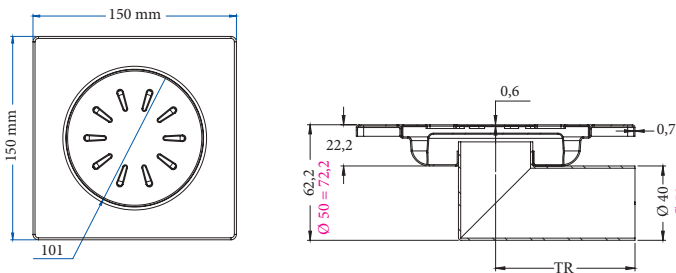

PREMIUM SLIM 20X20

Code	Outlet	Size	
HORIZONTAL OUTLET			
3046.0Y040K.020.1	Ø 40	20x20 cm	24
3046.0Y050K.020.1	Ø 50	20x20 cm	24
VERTICAL OUTLET			
3046.0A040K.015.1	Ø 50	20x20 cm	24
3046.0A050K.015.1	Ø 70	20x20 cm	24

*Stainless body / Stainless steel grid / Stainless scent holder
 Корпус из нержавеющей стали / Нержавеющая решетка
 هيكل مقاوم للصدأ / شبكة مقاومة للصدأ / حابس رائحة غير القابل للصدأ

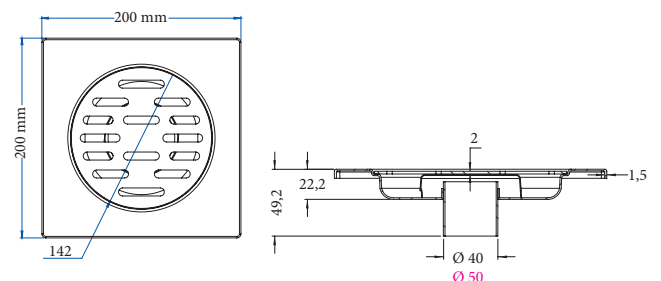
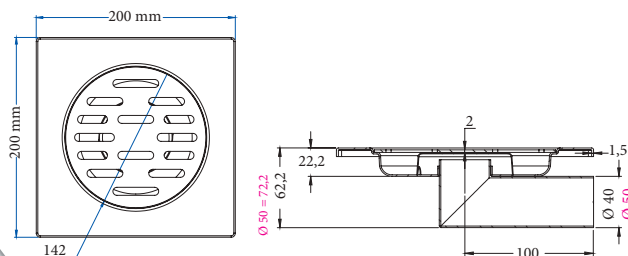

LIBRA 10x10

Code	Outlet	Size	
HORIZONTAL OUTLET			
3065.0A050K.10.1	Ø 50	10x10 cm	50
<p>Трап под плиткой / Пластиковый ствол / Корпус из Нержавеющей стали قناة دش/ هيكل مقاوم للصدأ / مع مخرج ٥٠ ملم / و غطاء مقاوم للصدأ من اجل السيراميك / مع مانع الروائح الكريهة</p>			



VERTICAL OUTLET

3065.0Y050K.10.1	Ø 50	10x10 cm	50
<p>Трап под плиткой / Пластиковый ствол / Корпус из Нержавеющей стали قناة دش/ هيكل مقاوم للصدأ / مع مخرج متحرك ٥٠ ملم / و غطاء مقاوم للصدأ من اجل السيراميك / مع مانع الروائح الكريهة</p>			



Stainless Steel Body / Tile Insertable Grid

VERTICAL OUTLET

3066.0Y050K.10.1	Ø 50	10x10 cm	50
<p>Трап под плиткой / Пластиковый ствол / Корпус из Нержавеющей стали قناة دش/ هيكل مقاوم للصدأ / مع مخرج متحرك ٥٠ ملم / و غطاء مقاوم للصدأ من اجل السيراميك / مع مانع الروائح الكريهة</p>			



Stainless Steel Body / Tile Insertable Grid

LIBRA 15x15

Code	Outlet	Size	
HORIZONTAL OUTLET			
3065.0A050K.015.1	Ø 50	15x15 cm	50
<p>Трап под плиткой / Пластиковый ствол / Корпус из Нержавеющей стали قناة دش/ هيكل مقاوم للصدأ / مع مخرج ٥٠ ملم / و غطاء مقاوم للصدأ من اجل السيراميك / مع مانع الروائح الكريهة</p>			



VERTICAL OUTLET

3065.0Y050K.015.1	Ø 50	15x15 cm	50
<p>Трап под плиткой / Пластиковый ствол / Корпус из Нержавеющей стали قناة دش/ هيكل مقاوم للصدأ / مع مخرج متحرك ٥٠ ملم / و غطاء مقاوم للصدأ من اجل السيراميك / مع مانع الروائح الكريهة</p>			



Stainless Steel Body / Tile Insertable Grid

VERTICAL OUTLET

3066.0Y050K.015.1	Ø 50	15x15 cm	50
<p>Трап под плиткой / Пластиковый ствол / Корпус из Нержавеющей стали قناة دش/ هيكل مقاوم للصدأ / مع مخرج متحرك ٥٠ ملم / و غطاء مقاوم للصدأ من اجل السيراميك / مع مانع الروائح الكريهة</p>			



Stainless Steel Body / Tile Insertable Grid

PEARL

Code	Outlet	Size	
10x10			
3155.1010P0.100.0	Without lap	1 mm	10x10 cm 50
3155.1010P0.120.0	Without lap	1.20 mm	10x10 cm 50
3155.1010P0.150.0	Without lap	1.50 mm	10x10 cm 50
15x15			
3155.1515P0.100.0	Without lap	1 mm	15x15 cm 50
3155.1515P1.100.0	With lap	1 mm	15x15 cm 50
3155.1515P0.120.0	Without lap	1.20 mm	15x15 cm 50
3155.1515P1.120.0	With lap	1.20 mm	15x15 cm 50
3155.1515P0.150.0	Without lap	1.50 mm	15x15 cm 50
3155.1515P1.150.0	With lap	1.50mm	15x15 cm 50
20x20			
3155.2020P0.100.0	Without lap	1 mm	20x20 cm 30
3155.2020P1.100.0	With lap	1 mm	20x20 cm 30
3155.2020P0.120.0	Without lap	1.20 mm	20x20 cm 30
3155.2020P1.120.0	With lap	1.20 mm	20x20 cm 30
3155.2020P0.150.0	Without lap	1.50 mm	20x20 cm 30
3155.2020P1.150.0	With lap	1.50mm	20x20 cm 30

QUATTRO

Code	Outlet	Size	
10x10			
3159.1010P0.100.0	Without lap	1 mm	10x10 cm 50
3159.1010P0.120.0	Without lap	1.20 mm	10x10 cm 50
3159.1010P0.150.0	Without lap	1.50 mm	10x10 cm 50
15x15			
3159.1515P0.100.0	Without lap	1 mm	15x15 cm 50
3159.1515P1.100.0	With lap	1 mm	15x15 cm 50
3159.1515P0.120.0	Without lap	1.20 mm	15x15 cm 50
3159.1515P1.120.0	With lap	1.20 mm	15x15 cm 50
3159.1515P0.150.0	Without lap	1.50 mm	15x15 cm 50
3159.1515P1.150.0	With lap	1.50mm	15x15 cm 50
20x20			
3159.2020P0.100.0	Without lap	1 mm	20x20 cm 30
3159.2020P1.100.0	With lap	1 mm	20x20 cm 30
3159.2020P0.120.0	Without lap	1.20 mm	20x20 cm 30
3159.2020P1.120.0	With lap	1.20 mm	20x20 cm 30
3159.2020P0.150.0	Without lap	1.50 mm	20x20 cm 30
3159.2020P1.150.0	With lap	1.50mm	20x20 cm 30

NILE

Code	Outlet	Size	
15x15			
3156.1515P0.100.0	Without lap	1 mm	15x15 cm 50
3156.1515P1.100.0	With lap	1 mm	15x15 cm 50
3156.1515P0.120.0	Without lap	1.20 mm	15x15 cm 50
3156.1515P1.120.0	With lap	1.20 mm	15x15 cm 50
3156.1515P0.150.0	Without lap	1.50 mm	15x15 cm 50
3156.1515P1.150.0	With lap	1.50mm	15x15 cm 50
20x20			
3156.2020P0.100.0	Without lap	1 mm	20x20 cm 30
3156.2020P1.100.0	With lap	1 mm	20x20 cm 30
3156.2020P0.120.0	Without lap	1.20 mm	20x20 cm 30
3156.2020P1.120.0	With lap	1.20 mm	20x20 cm 30
3156.2020P0.150.0	Without lap	1.50 mm	20x20 cm 30
3156.2020P1.150.0	With lap	1.50mm	20x20 cm 30



Stainless body / Трап из нержавеющей стали тонкий тип
هيكل مقاوم للصدأ



Stainless body / Трап из нержавеющей стали тонкий тип
هيكل مقاوم للصدأ



Stainless body / Трап из нержавеющей стали тонкий тип
هيكل مقاوم للصدأ



Stainless body / Трап из нержавеющей стали тонкий тип
هيكل مقاوم للصدأ



Stainless body / Трап из нержавеющей стали тонкий тип
هيكل مقاوم للصدأ



Stainless body / Трап из нержавеющей стали тонкий тип
هيكل مقاوم للصدأ

DREAM

Code	Outlet	Size	
10x10			
3158.1010P0.100.0	Without lap	1 mm	10x10 cm 50
3158.1010P0.120.0	Without lap	1.20 mm	10x10 cm 50
3158.1010P0.150.0	Without lap	1.50 mm	10x10 cm 50

15x15

3158.1515P0.100.0	Without lap	1 mm	15x15 cm 50
3158.1515P1.100.0	With lap	1 mm	15x15 cm 50
3158.1515P0.120.0	Without lap	1.20 mm	15x15 cm 50
3158.1515P1.120.0	With lap	1.20 mm	15x15 cm 50
3158.1515P0.150.0	Without lap	1.50 mm	15x15 cm 50
3158.1515P1.150.0	With lap	1.50mm	15x15 cm 50

20x20

3158.2020P0.100.0	Without lap	1 mm	20x20 cm 30
3158.2020P1.100.0	With lap	1 mm	20x20 cm 30
3158.2020P0.120.0	Without lap	1.20 mm	20x20 cm 30
3158.2020P1.120.0	With lap	1.20 mm	20x20 cm 30
3158.2020P0.150.0	Without lap	1.50 mm	20x20 cm 30
3158.2020P1.150.0	With lap	1.50mm	20x20 cm 30

QUEEN

Code	Outlet	Size	
10x10			
3157.1010P0.100.0	Without lap	1 mm	10x10 cm 50
3157.1010P0.120.0	Without lap	1.20 mm	10x10 cm 50
3157.1010P0.150.0	Without lap	1.50 mm	10x10 cm 50

15x15

3157.1515P0.100.0	Without lap	1 mm	15x15 cm 50
3157.1515P1.100.0	With lap	1 mm	15x15 cm 50
3157.1515P0.120.0	Without lap	1.20 mm	15x15 cm 50
3157.1515P1.120.0	With lap	1.20 mm	15x15 cm 50
3157.1515P0.150.0	Without lap	1.50 mm	15x15 cm 50
3157.1515P1.150.0	With lap	1.50mm	15x15 cm 50

20x20

3157.2020P0.100.0	Without lap	1 mm	20x20 cm 30
3157.2020P1.100.0	With lap	1 mm	20x20 cm 30
3157.2020P0.120.0	Without lap	1.20 mm	20x20 cm 30
3157.2020P1.120.0	With lap	1.20 mm	20x20 cm 30
3157.2020P0.150.0	Without lap	1.50 mm	20x20 cm 30
3157.2020P1.150.0	With lap	1.50mm	20x20 cm 30

SUNRISE

Code	Outlet	Size	
15x15			
3150.1515P0.100.0	Without lap	1 mm	15x15 cm 50
3150.1515P1.100.0	With lap	1 mm	15x15 cm 50
3150.1515P0.120.0	Without lap	1.20 mm	15x15 cm 50
3150.1515P1.120.0	With lap	1.20 mm	15x15 cm 50
3150.1515P0.150.0	Without lap	1.50 mm	20x20 cm 50
3150.1515P1.150.0	With lap	1.50 mm	20x20 cm 50

SIPHON UPPER BODY

LINE

Code	Outlet	Size	
10X10			
5101.0A100.10.1	Ø 100	10x10 cm	150
15X15			
5107.0A100.15.1	Ø 100	15x15 cm	80

*Plastic body / Stainless steel grid / Odor blocking by waters
 *пластичное тело / Гидро и сухой затвор / Нержавеющая решетка
 هيكل بلاستيكي / شبكة مقاومة للصدأ / حابس رائحة بصمام مائي



LEGAL

Code	Outlet	Size	
10X10			
5102.0A100.10.1	Ø 100	10x10 cm	150
15X15			
5108.0A100.15.1	Ø 100	15x15 cm	80

*Plastic body / Stainless steel grid and frame / Odor blocking by waters
 *пластичное тело / Гидро и сухой затвор / Решетка из нержавеющей стали и рамка
 هيكل بلاستيكي / شبكة وإطار مقاوم للصدأ / حابس رائحة بصمام مائي



PREMIUM

Code	Outlet	Size	
10X10			
5105.0A100.10.0	Ø 100	10x10 cm	120
15X15			
5111.0A100.15.0	Ø 100	15x15 cm	80

*Plastic body / Stainless steel outer frame and full cover / Odor blocking by water
 *пластичное тело / Гидро и сухой затвор Рама из нержавеющей стали и полное покрытие
 هيكل بلاستيكي / الإطار الخارجي الفولاذ المقاوم للصدأ والغطاء الكامل حابس رائحة بصمام مائي



RING

Code	Outlet	
RING		
1207001100100	Ø 100	150
RING WITH GRILL		
5112.0A100.00.1	Ø 100	150

Трап овальный



SQUARE



INDEX



SCALA 10x10

Code	Outlet	Size	
VERTICAL OUTLET			
5103.0A100.10.0	Ø 100	10x10 cm	120

*Plastic body / Odor blocking by water / Compatible with ceramic Plastic interior frame
 *трап под плитку / пластиковый ствол / сухой затвор
 هيكل بلاستيكي / حابس رائحة بصمام مائي / متوافق مع السيراميك إطار الداخلية من البلاستيك

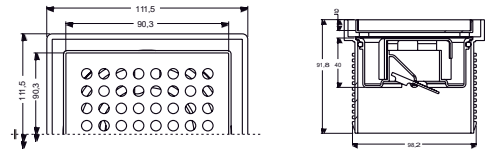

SCALA 15x15



Code	Outlet	Size	
VERTICAL OUTLET			
5109.0A100.15.0	Ø 100	15x15 cm	80

*Plastic body / Odor blocking by water / Compatible with ceramic Plastic interior frame
 *трап под плитку / пластиковый ствол / сухой затвор
 هيكل بلاستيكي / حابس رائحة بصمام مائي / متوافق مع السيراميك إطار الداخلية من البلاستيك

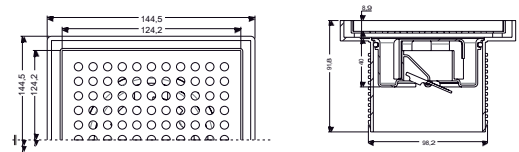

ELIT 10x10



Code	Outlet	Size	
VERTICAL OUTLET			
5104.0A100.10.0	Ø 100	10x10 cm	120

*Plastic body / Stainless interior and exterior frame / Odor blocking by water / Compatible with ceramic Plastic interior frame
 *трап под плитку / пластиковый ствол / рама из нержавеющей стали / сухой затвор
 هيكل بلاستيكي / حابس رائحة بصمام مائي / متوافق مع السيراميك إطار الداخلية من البلاستيك

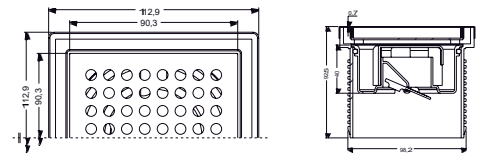

ELIT 15x15



Code	Outlet	Size	
VERTICAL OUTLET			
5110.0A100.15.0	Ø 100	15x15 cm	80

*Plastic body / Stainless interior and exterior frame / Odor blocking by water / Compatible with ceramic Plastic interior frame
 *трап под плитку / пластиковый ствол / рама из нержавеющей стали / сухой затвор
 هيكل بلاستيكي / حابس رائحة بصمام مائي / متوافق مع السيراميك إطار الداخلية من البلاستيك

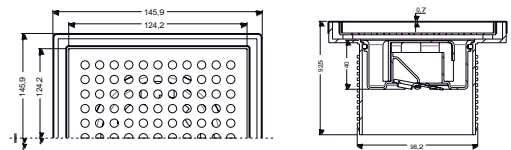

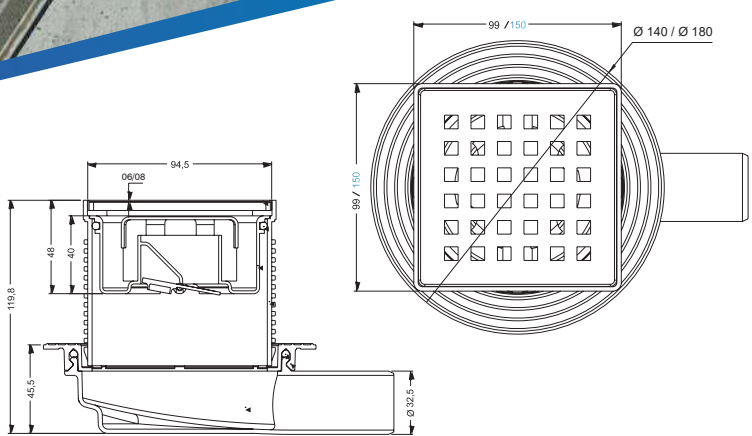

Ø 32 HORIZONTAL OUTLET

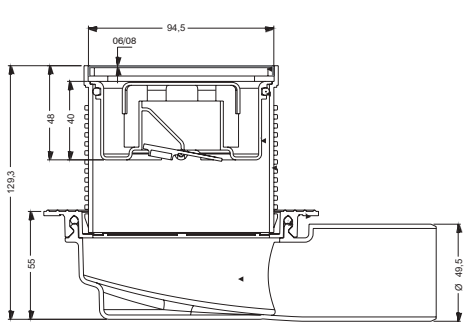
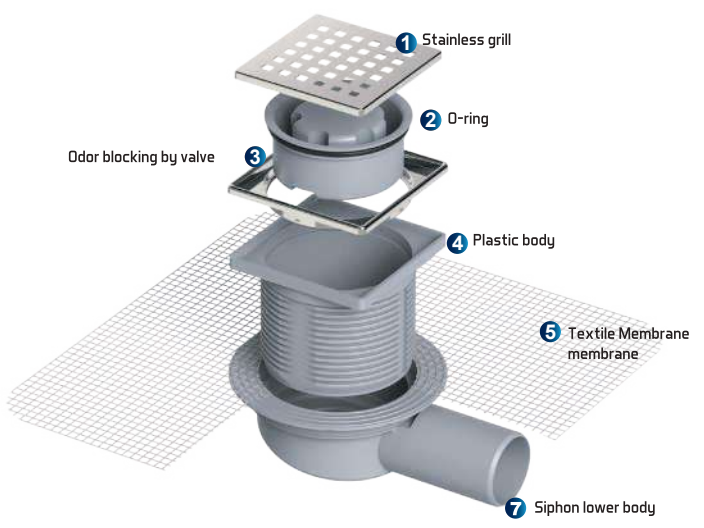

Ø 50 HORIZONTAL OUTLET

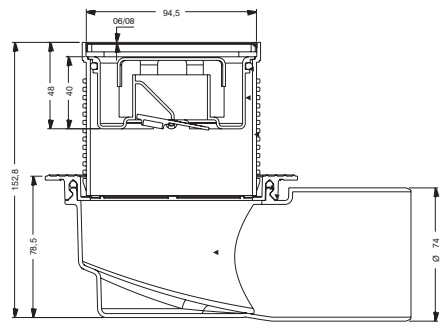

Ø 70 HORIZONTAL OUTLET

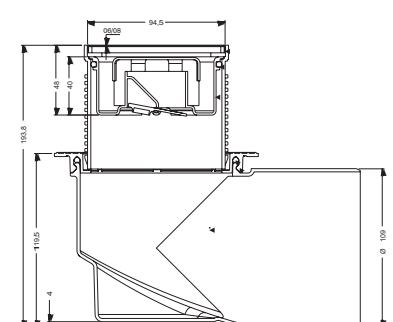

Ø 100 HORIZONTAL OUTLET



140MM

Code	Outlet	Height	
HORIZONTAL OUTLET			
5014.0Y032.00.0	Ø 32	46 mm	125
5014.0Y040.00.0	Ø 40	55 mm	125
5014.0Y050.00.0	Ø 50	55 mm	100
5014.0Y070.00.0	Ø 70	79 mm	75
5014.0Y100.00.0	Ø 100	115 mm	75
VERTICAL OUTLET			
5014.0A040.00.0	Ø 40	96 mm	140
5014.0A050.00.0	Ø 50	96 mm	140
5014.0A070.00.0	Ø 70	96 mm	125
5014.0A100.00.0	Ø 100	96 mm	75

Siphon lower body / пластиковое тело
الجسم السفلي



180MM

Code	Outlet	Height	
HORIZONTAL OUTLET			
5018.0Y032.00.0	Ø 32	46 mm	100
5018.0Y040.00.0	Ø 40	55 mm	100
5018.0Y050.00.0	Ø 50	55 mm	100
5018.0Y070.00.0	Ø 70	79 mm	75
5018.0Y100.00.0	Ø 100	115 mm	30
VERTICAL OUTLET			
5018.0A040.00.0	Ø 40	96 mm	100
5018.0A050.00.0	Ø 50	96 mm	100
5018.0A070.00.0	Ø 70	96 mm	85
5018.0A100.00.0	Ø 100	96 mm	75

Siphon lower body / пластиковое тело
الجسم السفلي



210MM

Code	Outlet	Height	
HORIZONTAL OUTLET			
5021.0Y032.00.0	Ø 32	46 mm	100
5021.0Y040.00.0	Ø 40	55 mm	100
5021.0Y050.00.0	Ø 50	55 mm	100
5021.0Y070.00.0	Ø 70	79 mm	70
5021.0Y100.00.0	Ø 100	115 mm	30
VERTICAL OUTLET			
5021.0A040.00.0	Ø 40	96 mm	100
5021.0A050.00.0	Ø 50	96 mm	100
5021.0A070.00.0	Ø 70	96 mm	100
5021.0A100.00.0	Ø 100	96 mm	70

Siphon lower body / пластиковое тело
الجسم السفلي

140 MM MESH

Code	Outlet	Height	
HORIZONTAL OUTLET			
5014.FY032.00.0	Ø 32	46 mm	125
5014.FY040.00.0	Ø 40	55 mm	125
5014.FY050.00.0	Ø 50	55 mm	100
5014.FY070.00.0	Ø 70	79 mm	75
5014.FY100.00.0	Ø 100	115 mm	75
VERTICAL OUTLET			
5014.FA040.00.0	Ø 40	96 mm	100
5014.FA050.00.0	Ø 50	96 mm	100
5014.FA070.00.0	Ø 70	96 mm	75
5014.FA100.00.0	Ø 100	96 mm	75

Siphon lower body / пластиковое тело
الجسم السفلي



180MM MESH

Code	Outlet	Height	
HORIZONTAL OUTLET			
5018.FY032.00.0	Ø 32	46 mm	100
5018.FY040.00.0	Ø 40	55 mm	100
5018.FY050.00.0	Ø 50	55 mm	100
5018.FY070.00.0	Ø 70	79 mm	75
5018.FY100.00.0	Ø 100	115 mm	72
VERTICAL OUTLET			
5018.FA040.00.0	Ø 40	96 mm	100
5018.FA050.00.0	Ø 50	96 mm	90
5018.FA070.00.0	Ø 70	96 mm	85
5018.FA100.00.0	Ø 100	96 mm	72

Siphon lower body / пластиковое тело
الجسم السفلي



140MM T. MEMBRANE

Code	Outlet	Height	
HORIZONTAL OUTLET			
5014.TY032.00.0	Ø 32	46 mm	125
5014.TY040.00.0	Ø 40	55 mm	125
5014.TY050.00.0	Ø 50	55 mm	100
5014.TY070.00.0	Ø 70	79 mm	75
5014.TY100.00.0	Ø 100	115 mm	75
VERTICAL OUTLET			
5014.TA040.00.0	Ø 40	96 mm	100
5014.TA050.00.0	Ø 50	96 mm	100
5014.TA070.00.0	Ø 70	96 mm	75
5014.TA100.00.0	Ø 100	96 mm	75

Siphon lower body / пластиковое тело
الجسم السفلي

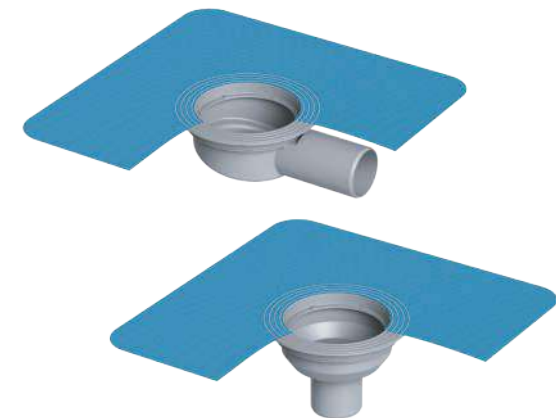

180 MM T.MEMBRANE

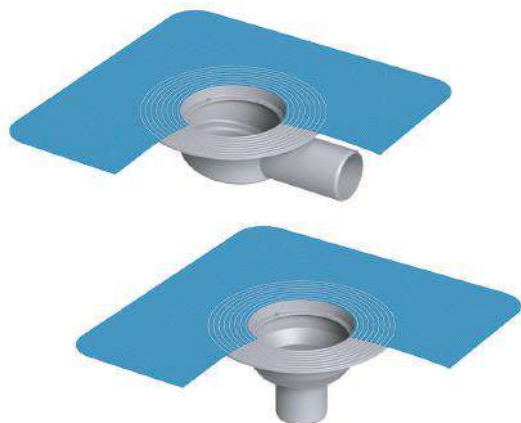

Code	Outlet	Height	
HORIZONTAL OUTLET			
5018.TY032.00.0	Ø 32	46 mm	100
5018.TY040.00.0	Ø 40	55 mm	100
5018.TY050.00.0	Ø 50	55 mm	90
5018.TY070.00.0	Ø 70	79 mm	75
5018.TY100.00.0	Ø 100	115 mm	50
VERTICAL OUTLET			
5018.TA040.00.0	Ø 40	96 mm	85
5018.TA050.00.0	Ø 50	96 mm	85
5018.TA070.00.0	Ø 70	96 mm	75
5018.TA100.00.0	Ø 100	96 mm	75

Siphon lower body / пластиковое тело
الجسم السفلي

210 MM MEMBRANE



Code	Outlet	Height	
HORIZONTAL OUTLET			
5021.MY032.00.0	Ø 32	50 mm	35
5021.MY040.00.0	Ø 40	59 mm	35
5021.MY050.00.0	Ø 50	59 mm	35
5021.MY070.00.0	Ø 70	84 mm	30
5021.MY100.00.0	Ø 100	119 mm	30
VERTICAL OUTLET			
5021.MA040.00.0	Ø 40	100 mm	30
5021.MA050.00.0	Ø 50	100 mm	30
5021.MA070.00.0	Ø 70	100 mm	30
5021.MA100.00.0	Ø 100	100 mm	30

Plastic body / Stainless Steel Flanges set
пластичное тело / Изоляция совместимый / Мембраны
الجسم السفلي

VERTICAL OUTLET

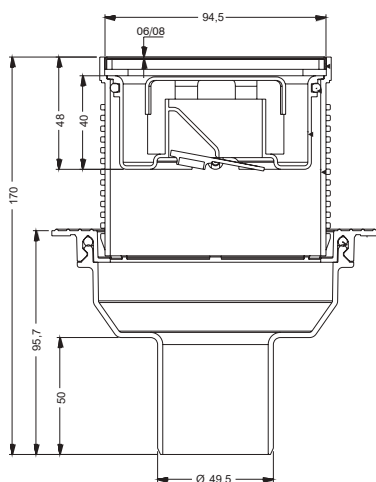

Ø 50 VERTICAL OUTLET

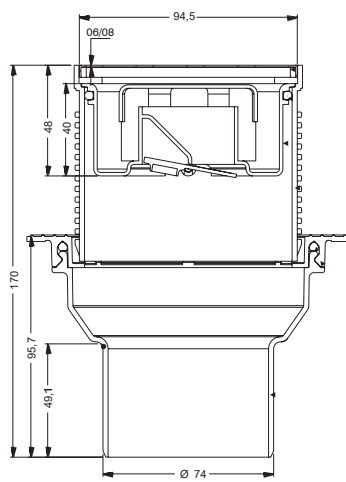

Ø 70 VERTICAL OUTLET

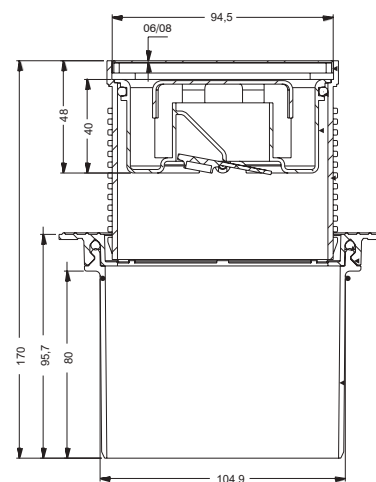

Ø 100 VERTICAL OUTLET

140 MM 10x10 SIPHON

Code	Outlet	Size	
HORIZONTAL OUTLET			
5054.0Y032.10.1	Ø 32	10x10 cm	50
5054.0Y040.10.1	Ø 40	10x10 cm	50
5054.0Y050.10.1	Ø 50	10x10 cm	50
5054.0Y070.10.1	Ø 70	10x10 cm	50
5054.0Y100.10.1	Ø 100	10x10 cm	50
VERTICAL OUTLET			
5054.0A040.10.1	Ø 40	10x10 cm	50
5054.0A050.10.1	Ø 50	10x10 cm	50
5054.0A070.10.1	Ø 70	10x10 cm	50
5054.0A100.10.1	Ø 100	10x10 cm	50

*Plastic body / Stainless steel grid / Odor blocking by water
 *пластичное тело / Нержавеющая решетка / Сухой Затвор
 هيكل بلاستيكي / شبكة مقاومة للصدأ / حابس رائحة مائي بصمام



180MM 10X10

Code	Outlet	Size	
HORIZONTAL OUTLET			
5058.0Y032.10.1	Ø 32	10x10 cm	50
5058.0Y040.10.1	Ø 40	10x10 cm	50
5058.0Y050.10.1	Ø 50	10x10 cm	50
5058.0Y070.10.1	Ø 70	10x10 cm	50
5058.0Y100.10.1	Ø 100	10x10 cm	50
VERTICAL OUTLET			
5058.0A040.10.1	Ø 40	10x10 cm	50
5058.0A050.10.1	Ø 50	10x10 cm	50
5058.0A070.10.1	Ø 70	10x10 cm	50
5058.0A100.10.1	Ø 100	10x10 cm	50

*Plastic body / Stainless steel grid / Odor blocking by water
 *пластичное тело / Нержавеющая решетка / Сухой Затвор
 هيكل بلاستيكي / شبكة مقاومة للصدأ / حابس رائحة مائي بصمام



180MM 15X15

Code	Outlet	Size	
HORIZONTAL OUTLET			
5058.0Y032.15.1	Ø 32	15x15cm	50
5058.0Y040.15.1	Ø 40	15x15cm	50
5058.0Y050.15.1	Ø 50	15x15cm	50
5058.0Y070.15.1	Ø 70	15x15cm	50
5058.0Y100.15.1	Ø 100	15x15cm	50
VERTICAL OUTLET			
5058.0A040.15.1	Ø 40	15x15cm	50
5058.0A050.15.1	Ø 50	15x15cm	50
5058.0A070.15.1	Ø 70	15x15cm	50
5058.0A100.15.1	Ø 100	15x15cm	50

*Plastic body / Stainless steel grid / Odor blocking by water
 *пластичное тело / Нержавеющая решетка / Сухой Затвор
 هيكل بلاستيكي / شبكة مقاومة للصدأ / حابس رائحة مائي بصمام



140 MM 10x10 MESH



Code	Outlet	Size	
HORIZONTAL OUTLET			
5054.FY032.10.1	Ø 32	10x10 cm	50
5054.FY040.10.1	Ø 40	10x10 cm	50
5054.FY050.10.1	Ø 50	10x10 cm	50
5054.FY070.10.1	Ø 70	10x10 cm	50
5054.FY100.10.1	Ø 100	10x10 cm	50
VERTICAL OUTLET			
5054.FA040.10.1	Ø 40	10x10 cm	50
5054.FA050.10.1	Ø 50	10x10 cm	50
5054.FA070.10.1	Ø 70	10x10 cm	50
5054.FA100.10.1	Ø 100	10x10 cm	50

*Plastic body / Stainless steel grid / Odor blocking by water
 *пластичное тело / Нержавеющая решетка / Сухой Затвор
 هيكل بلاستيكي / شبكة مقاومة للصدأ / حابس رائحة مائي بصمام

180 MM 10x10 MESH



Code	Outlet	Size	
HORIZONTAL OUTLET			
5058.FY032.10.1	Ø 32	10x10 cm	50
5058.FY040.10.1	Ø 40	10x10 cm	50
5058.FY050.10.1	Ø 50	10x10 cm	50
5058.FY070.10.1	Ø 70	10x10 cm	50
5058.FY100.10.1	Ø 100	10x10 cm	50
VERTICAL OUTLET			
5058.FA040.10.1	Ø 40	10x10 cm	50
5058.FA050.10.1	Ø 50	10x10 cm	50
5058.FA070.10.1	Ø 70	10x10 cm	50
5058.FA100.10.1	Ø 100	10x10 cm	50

*Plastic body / Stainless steel grid / Odor blocking by water
 *пластичное тело / Нержавеющая решетка / Сухой Затвор
 هيكل بلاستيكي / شبكة مقاومة للصدأ / حابس رائحة مائي بصمام

180 MM 15x15 MESH



Code	Outlet	Size	
HORIZONTAL OUTLET			
5058.FY032.15.1	Ø 32	15x15cm	50
5058.FY040.15.1	Ø 40	15x15cm	50
5058.FY050.15.1	Ø 50	15x15cm	50
5058.FY070.15.1	Ø 70	15x15cm	50
5058.FY100.15.1	Ø 100	15x15cm	50
VERTICAL OUTLET			
5058.FA040.15.1	Ø 40	15x15cm	50
5058.FA050.15.1	Ø 50	15x15cm	50
5058.FA070.15.1	Ø 70	15x15cm	50
5058.FA100.15.1	Ø 100	15x15cm	50

*Plastic body / Stainless steel grid / Odor blocking by water
 *пластичное тело / Нержавеющая решетка / Сухой Затвор
 هيكل بلاستيكي / شبكة مقاومة للصدأ / حابس رائحة مائي بصمام

140 MM 10x10 T.MEMBRANE

Code	Outlet	Size	
HORIZONTAL OUTLET			
5054.TY032.10.1	Ø 32	10x10 cm	50
5054.TY040.10.1	Ø 40	10x10 cm	50
5054.TY050.10.1	Ø 50	10x10 cm	50
5054.TY070.10.1	Ø 70	10x10 cm	50
5054.TY100.10.1	Ø 100	10x10 cm	50
VERTICAL OUTLET			
5054.TA040.10.1	Ø 40	10x10 cm	50
5054.TA050.10.1	Ø 50	10x10 cm	50
5054.TA070.10.1	Ø 70	10x10 cm	50
5054.TA100.10.1	Ø 100	10x10 cm	50

*Plastic body / Stainless steel grid / Odor blocking by water
 *пластичное тело / Нержавеющая решетка / Сухой Затвор
 هيكل بلاستيكي / شبكة مقاومة للصدأ / حابس رائحة مائي بصمام



180 MM 10x10 T.MEMBRANE

Code	Outlet	Size	
HORIZONTAL OUTLET			
5058.TY032.10.1	Ø 32	10x10 cm	50
5058.TY040.10.1	Ø 40	10x10 cm	50
5058.TY050.10.1	Ø 50	10x10 cm	50
5058.TY070.10.1	Ø 70	10x10 cm	50
5058.TY100.10.1	Ø 100	10x10 cm	50
VERTICAL OUTLET			
5058.TA040.10.1	Ø 40	10x10 cm	50
5058.TA050.10.1	Ø 50	10x10 cm	50
5058.TA070.10.1	Ø 70	10x10 cm	50
5058.TA100.10.1	Ø 100	10x10 cm	50

*Plastic body / Stainless steel grid / Odor blocking by water
 *пластичное тело / Нержавеющая решетка / Сухой Затвор
 هيكل بلاستيكي / شبكة مقاومة للصدأ / حابس رائحة مائي بصمام



180 MM 15x15 T.MEMBRANE

Code	Outlet	Size	
HORIZONTAL OUTLET			
5058.TY032.15.1	Ø 32	15x15cm	50
5058.TY040.15.1	Ø 40	15x15cm	50
5058.TY050.15.1	Ø 50	15x15cm	50
5058.TY070.15.1	Ø 70	15x15cm	50
5058.TY100.15.1	Ø 100	15x15cm	50
VERTICAL OUTLET			
5058.TA040.15.1	Ø 40	15x15cm	50
5058.TA050.15.1	Ø 50	15x15cm	50
5058.TA070.15.1	Ø 70	15x15cm	50
5058.TA100.15.1	Ø 100	15x15cm	50

*Plastic body / Stainless steel grid / Odor blocking by water
 *пластичное тело / Нержавеющая решетка / Сухой Затвор
 هيكل بلاستيكي / شبكة مقاومة للصدأ / حابس رائحة مائي بصمام

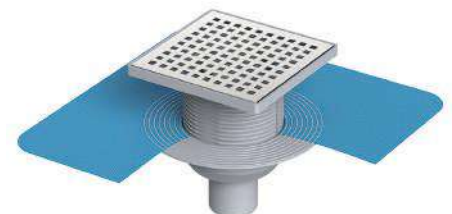
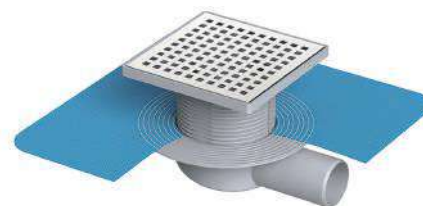



210 MM 10x10 MEMBRANE

Code	Outlet	Size	
HORIZONTAL OUTLET			
5061.MY032.10.1	Ø 32	10x10 cm	20
5061.MY040.10.1	Ø 40	10x10 cm	20
5061.MY050.10.1	Ø 50	10x10 cm	20
5061.MY070.10.1	Ø 70	10x10 cm	20
5061.MY100.10.1	Ø 100	10x10 cm	10

VERTICAL OUTLET

5061.MA040.10.1	Ø 40	10x10 cm	20
5061.MA050.10.1	Ø 50	10x10 cm	20
5061.MA070.10.1	Ø 70	10x10 cm	20
5061.MA100.10.1	Ø 100	10x10 cm	10

*Plastic body / Stainless steel grid / Odor blocking by water
 *пластичное тело / Нержавеющая решетка / Сухой Затвор
 هيكل بلاستيكي / شبكة مقاومة للصدأ / حابس رائحة مائي بصمام

210 MM 15x15 MEMBRANE

Code	Outlet	Size	
HORIZONTAL OUTLET			
5061.MY032.15.1	Ø 32	15x15cm	20
5061.MY040.15.1	Ø 40	15x15cm	20
5061.MY050.15.1	Ø 50	15x15cm	20
5061.MY070.15.1	Ø 70	15x15cm	20
5061.MY100.15.1	Ø 100	15x15cm	10

VERTICAL OUTLET

5061.MA040.15.1	Ø 40	15x15cm	20
5061.MA050.15.1	Ø 50	15x15cm	20
5061.MA070.15.1	Ø 70	15x15cm	20
5061.MA100.15.1	Ø 100	15x15cm	10

*Plastic body / Stainless steel grid / Odor blocking by water
 *пластичное тело / Нержавеющая решетка / Сухой Затвор
 هيكل بلاستيكي / شبكة مقاومة للصدأ / حابس رائحة مائي بصمام

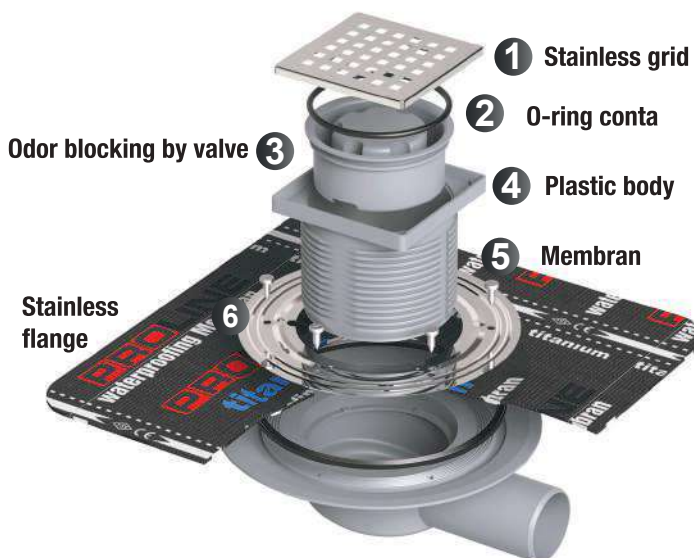

LINE



HM-31361

Code	Outlet	Size	
4072.0Y050K.020.1	Ø 50	20x20 cm	12
4072.0A050K.020.1	Ø 50	20x20 cm	12

تراپ квадратный
هيكل بلاستيكي / مع مخرج ٥٠ ملم / و شبكة مقاومه للصدأ / مع مانع الروائح الكريهة

LEGAL



HM-31363

Code	Outlet	Size	
4073.0Y050K.020.1	Ø 50	20x20 cm	12
4073.0A050K.020.1	Ø 50	20x20 cm	12

تراپ квадратный
هيكل مقاوم للصدأ / مع مخرج ٥٠ ملم / و شبكة مقاومه للصدأ / مع مانع الروائح الكريهة

LEGAL Y360°



HM-31363

Code	Outlet	Size	
4073.0Y360K.020.1	Ø 50	20x20 cm	12
4073.0A360K.020.1	Ø 50	20x20 cm	12

تراپ квадратный
هيكل مقاوم للصدأ / مع مخرج ٥٠ ملم / و شبكة مقاومه للصدأ / مع مانع الروائح الكريهة

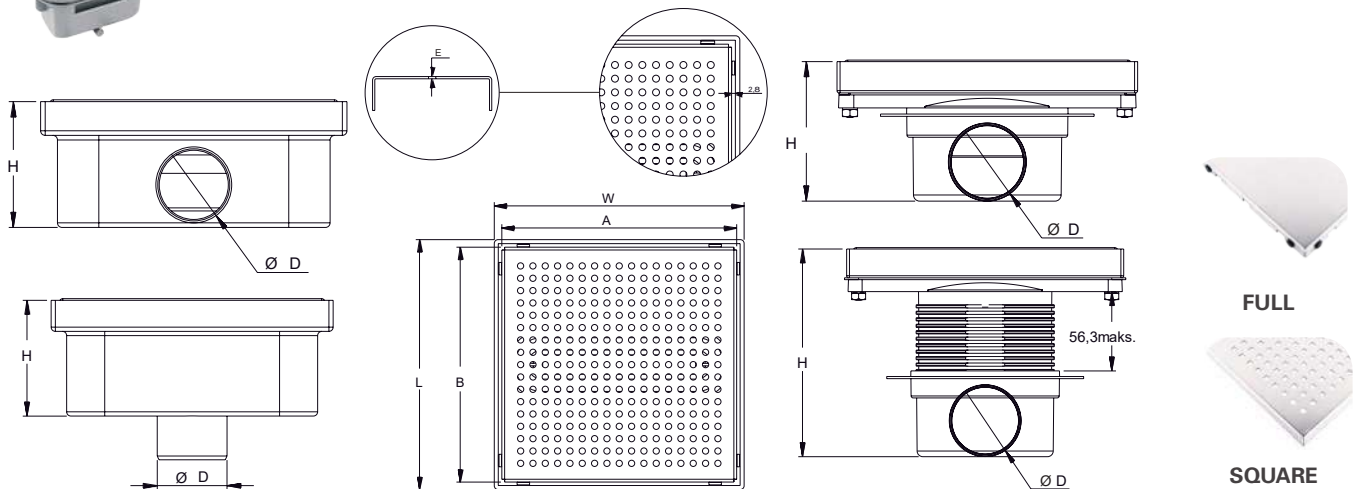

Code	W	L	H	Ø D	A	B	E
4072.0Y050K.020.0	200	200	82	49.5	188	188	1.5
4072.0A050K.020.0	200	200	82	49.5	188	188	1.5

Code	W	L	H	Ø D	A	B	E
4073.00360K.020.0	200	200	91	49.5	188	188	1.5
4073.0Y360K.020.0	200	200	148	49.5	188	188	1.5



HM-31361

LINE

Code	Outlet	Size	
4062.0Y050K.033.1	Ø 50	33 cm	12
4062.0A050K.033.1	Ø 50	33 cm	12

تراپ اضلاعی / مع مخرج ۵۰ ملم / و شبکه مقاومه للصدأ / مع مانع الروائح الكريهة
 трап угловой
 هيكل بلاستيكي / مع مخرج ۵۰ ملم / و شبکه مقاومه للصدأ / مع مانع الروائح الكريهة



HM-31363

LEGAL

Code	Outlet	Size	
4063.0Y050K.033.1	Ø 50	33 cm	12
4063.0A050K.033.1	Ø 50	33 cm	12

تراپ اضلاعی / مع مخرج ۵۰ ملم / و شبکه مقاومه للصدأ / مع مانع الروائح الكريهة
 هيكل مقاوم للصدأ / مع مخرج ۵۰ ملم / و شبکه مقاومه للصدأ / مع مانع الروائح الكريهة



HM-31363

LEGAL Y360°

Code	Outlet	Size	
4063.0Y360K.033.1	Ø 50	33 cm	12
4063.0A360K.033.1	Ø 50	33 cm	12

تراپ اضلاعی / مع مخرج ۵۰ ملم / و شبکه مقاومه للصدأ / مع مانع الروائح الكريهة
 هيكل مقاوم للصدأ / مع مخرج ۵۰ ملم / و شبکه مقاومه للصدأ / مع مانع الروائح الكريهة



FULL



SQUARE

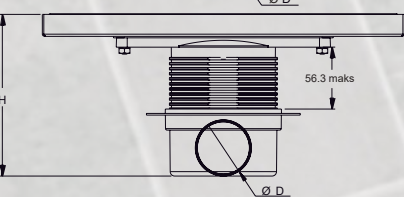
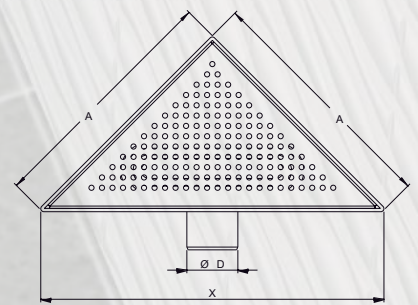
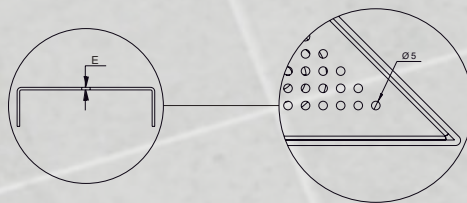
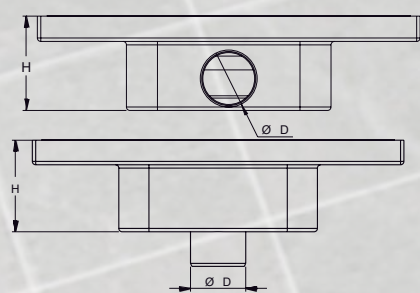

Code	H	Ø D	A	X	E
4062.0Y050K.033.0	84	49.5	234	330	1.5

Code	H	Ø D	A	X	E
4062.0A050K.033.0	84	49.5	234	330	1.5

Code	H	Ø D	A	X	E
4063.00360K.033.0	91	49.5	234	330	1.5

Code	H	Ø D	A	X	E
4063.0Y360K.033.0	147	49.5	234	330	1.5

Table measure "mm"